

USER INSTRUCTIONS

ENGLISH

vetec

V-LINK

67601 / 671201 / 672501 / 675501



Front

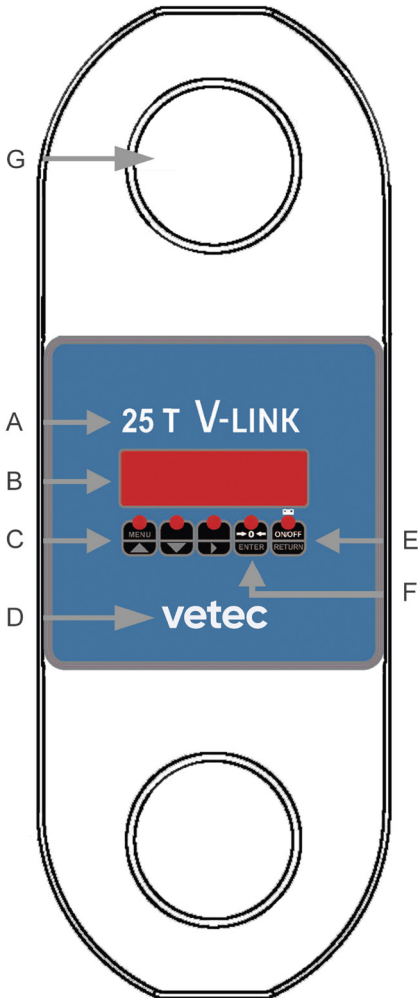

Back

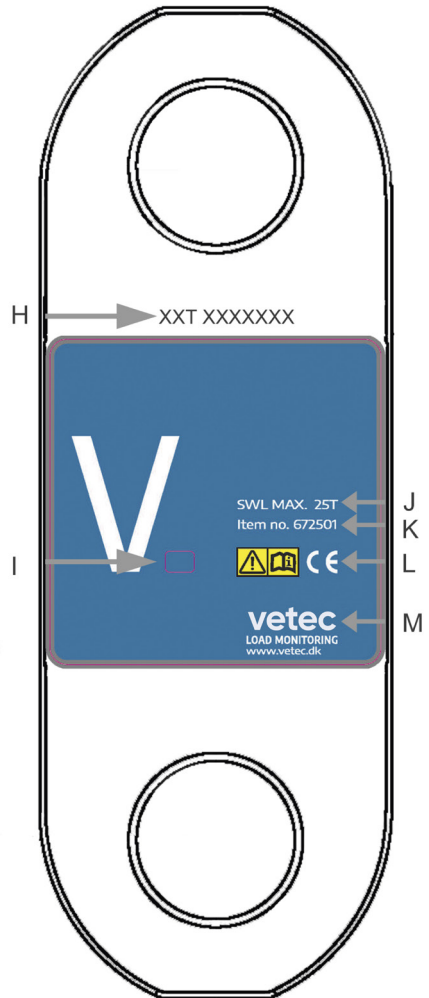

A	Capacity / Product brand	H	Capacity / Serial no. engraved
B	Red LED display	I	USB port (only for charging)
C	Operating panel	J	Safe Working Load (SWL)
D	Manufacturer name	K	Item no.
E	ON/OFF button	L	Read manual. CE
F	Tare button	M	Manufacturer name
G	Hole for shackle		

Quick start guide



The instructions contained in this quick guide do not replace the full manual. Make sure to read the whole manual carefully and correctly before use..

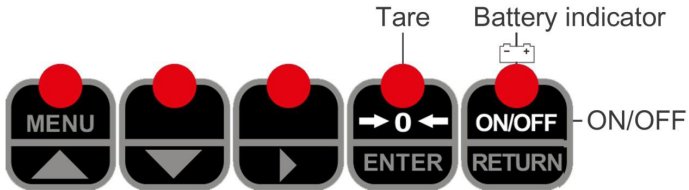

On/off

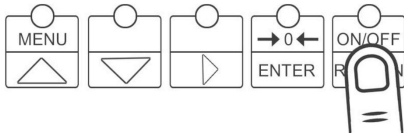

Press ON/OFF to turn on and off.

Once pressed, the display shows the software version number for a few seconds. Then the untared value will show.

*The dynamometer will not automatically turn off if not used.

Tare function

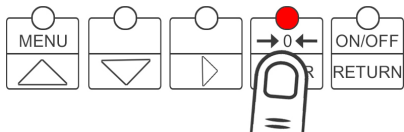

To activate the tare function press and hold →0← until the display shows 0 and the red button lights.

Press →0← to deactivate.

*The tare function will automatically deactivate when the dynamometer is turned off.

Peak hold /operating multiple dynamometers with wireless display

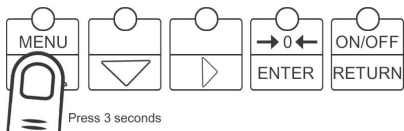

Press and hold MENU until the display shows 1. Use the arrows to choose between menu 1 and 2.

Menu 1: Peak hold function.
Menu 2: Operating multiple Dynamometers.

! See Advanced Settings for complete instruction.

Low battery

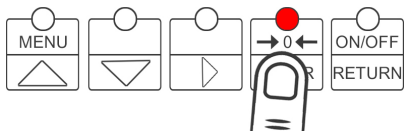

The battery indicator will flash when the battery is low and needs to be charged.

Summary

Thank you for purchasing a V-LINK dynamometer		Page
1.1	Important information	1
1.2	YouTube video tutorials	1
2.1	Technical specifications	2
2.2	Dimensions	2
2.3	Remote wireless display	3
2.4	Accessories	3
2.5	Applicable standards and regulations	4

Installation, operation and uninstalling		Page
3.1	Installation	4
3.2	Operation	5
3.3	Uninstallation	5
3.4	Overload	5
4.	Basic settings	6
5.	Menu / Advanced settings	7
5.1	Peak hold (Menu 1)	7
5.2	Operating multiple dynamometers in the same area (Menu 2)	8
6.	FAQ	9
7.	Charging	10

Service, repairs and maintenance		Page
8.1	Battery replacement	10
8.2	Regulatory audit / calibration	10
9.	Maintenance	11
10.	Waste Electrical and Electronic Equipment (WEEE)	11
11.	Warranty	11
12.	Vetec App	12

1. Thank you for purchasing a V-link dynamometer

The V-LINK dynamometer from Vetec A/S is designed with the purpose to increase efficiency and accuracy in all situations, including harsh and humid environments.

The development has been focused on optimizing features that make it easy for the operator to handle and operate the dynamometer and still achieve stable and accurate measurements. The increased ease of use is achieved, for example, by a flat design, simple menu structure, quick guide and fast charging with standard USB charger.

Achieving an IP67 class has been especially important in order to accommodate customers working in wet and humid environments. To test the functionality, the dynamometer has been immersed in 1 meter deep water for half an hour. The result was a fully functional product.

V-LINK is designed and manufactured in Denmark for high quality assurance and the service department provides professional support, repair and calibration service.

© Vetec A/S
Teknikvej 69
DK-5260 Odense S
Tlf.: +45 65919802
post@vetec.dk
www.vetec.dk

1.1 Important information

READ ALL INSTRUCTIONS AND WARNINGS CAREFULLY BEFORE INSTALLATION AND USE.

These instructions have been published by Vetec A/S and are not subject to any guarantee. The instructions may be withdrawn or revised by Vetec A/S at any time and without further notice. Corrections and additions will be added to the latest version of the instructions.

Carefully read through the safety instructions in this user manual and follow the installation and operating procedures and requirements. Failure to follow these warnings could result in serious injury and property damage.

Every use should be carried out according to current regulations in the country of use. Vetec A/S is not responsible for local regulations not being followed.

1.2 YouTube video tutorials



Visit Vetec's YouTube channel to watch tutorials demonstrating the installation, daily use and menu setup.

2.1 Technical specifications				
Item no.:	670601	671201	672501	675501
Max. working capacity	6.5T	12.5T	25T	55T
Accuracy (%)	+/- 0.2% FS			
Accuracy (Kg.)	+/-15 Kg.*	+/-30 Kg.*	+/-50 Kg.*	+/-120 Kg.*
Safe overload (%)	110%			
Safe overload (Kg.)	7150 Kg.	13200 Kg.	27500 Kg.	60500 Kg.
Breaking limit	500%			
Increment	5 Kg.	10 Kg.	10 Kg.	20 Kg.
Materials	High strength steel housing Fe/Zn12/A surface treatment according to ISO 2081			
IP class	IP 67			
Display	Bright LED			
Digit height	14 mm			
Digit color	Red			
Operating time	16-20 hours**			
Operation temp.	From -20°C to +50°C**			
Batteries	Build-in Li-on			
Charger	High quality USB charger			

*Rounded due to increment.

**Operating at low temperatures will decrease the operating time.

2.2 Dimensions

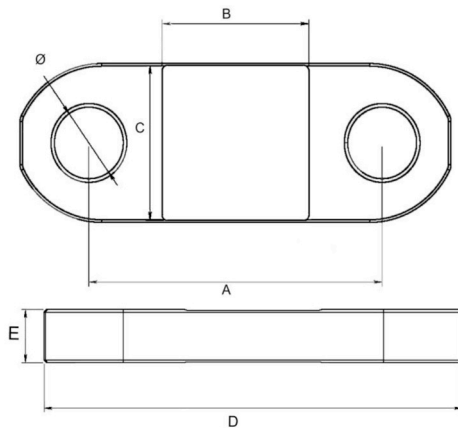

Item no.	A (mm)	B (mm)	C (mm)	D (mm)	E (mm)	Ø (mm)	Weight (Kg.)
670601	200.00	115.00	117.00	260.00	41.50	31.00	4.47
671201	200.00	115.00	117.00	281.00	41.50	37.30	5.65
672501	230.00	115.00	117.00	338.00	41.50	54.00	7.56
675501	282.00	115.00	155.00	440.00	46.00	73.00	16.93

2.3 Remote wireless display

Duplex communication and a long range enable measurements to be read from a long distance. To avoid interference the dynamometer and display can be connected using 99 different channels.

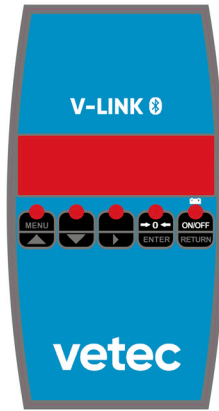

Item no.	WRDX01
Application areas	Only applicable with a V-LINK dynamometer.
Range	Up to 150 meters under optimal conditions.
Number of channels	99
Standard frequency	869.750 Mhz.
Communication form	Duplex
RF output power	10 mW
IP class	IP65
Operating time	16-20 hours. Operating at low temperatures will decrease the operating time.
Operating temp.	From -20°C to +50°C
Batteries	Build-in Li-on
Charger	Standard USB charger, as used for the V-LINK
Dimensions	H145 x L88 x W23 mm
Weight	0.15 kg.

2.4 Accesories

Item no.			
WRDXT01	Wireless remote display	G720661	USB cable
KUF-ABS01	Suitcase for 6.5T, 12.5T, 25T	G478231	Wall charger
KUF-ABS02	Suitcase for 55T		

2.5 Apply standards and regulations

- Calibrated with equipment traceable to national and international standards.
- Fe/Zn12/A surface treatment according to ISO 2081.

3. Installation, use and uninstal



"DANGER"

Product adjustment must only be performed by a qualified technician. The user shall ensure that the operator has taken note of this instruction, usage and maintenance manual before using the dynamometer.

3.1. Installation

The V-LINK must be fitted with shackles that comply with the SWL of the dynamometer and the applicable legislation in the country of use. Vetec A/S recommends Green Pin standard Shackles, G4163 and G-4161.

The maximum SWL is marked on the back foil of the dynamometer.

During installation ensure:

Adequate resistance of the load line's anchorage points in relation to the force that will be applied.

The compatibility of anchoring accessories in both ends of the dynamometer and compliance with applicable regulations.

Lock the shackles by tightening their pin to the limit and make sure that the safety latch hook works properly.

Respect the Dynamometer's maximum working capacity.

Free rotation. The Dynamometer must not be exposed to torsion force at any time.

G4163

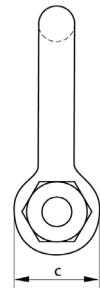
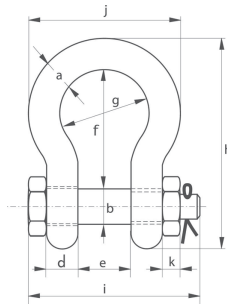
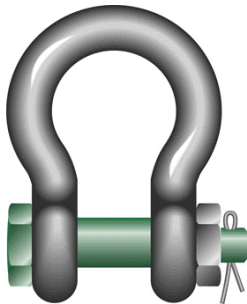

WLL	A	B	C	D	E	F	G	H	I	J	K	Weight
T	mm	mm	mm	mm	mm	mm	mm	mm	mm	mm	mm	Kg.
6.5	22	25	52	22	36	83	58	144	130	102	22	1.77
12.5	32	35	72	32	51	115	83	201	178	147	30	4.91
25	45	50	103	45	74	178	126	300	249	216	23	14.22
55	65	70	145	65	105	260	180	433	330	310	32	39.59

G4163

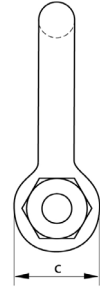
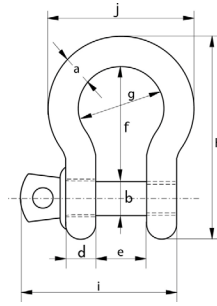

WLL	A	B	C	D	E	F	G	H	I	J	K	Weight
T	mm	mm	mm	mm	mm	mm	mm	mm	mm	mm	mm	Kg.
6.5	22	25	52	22	36	83	58	144	130	102	22	1.77
12.5	32	35	72	32	51	115	83	201	178	147	30	4.91
25	45	50	103	45	74	178	126	300	249	216	23	14.22
55	65	70	145	65	105	260	180	433	330	310	32	39.59

3.2. Use

- Use the V-LINK only in traction.
- The dynamometer can be used in all directions, including horizontally.
- Rapid changes in temperature may affect the accuracy. It is therefore recommended that the dynamometer is kept in stable temperature 20-30 minutes before use.

3.3. Uninstalling

- When uninstalling, first make sure that any tractive strain has been eliminated.
- Make sure to handle the dynamometer safely and avoid damage.
- When operated in corrosive environments wipe off all the external surfaces with a damp cloth.
- For optimal maintenance apply a thin layer of light oil, e.g. WD 40.

3.4 Overload



"DANGER"

In case of an overload it is imperative to completely release the stress on the dynamometer and conduct the following overload test.

Overload test: Turn the dynamometer off and on. If it indicates a value much higher or lower than the usual starting value, it has been permanently damaged. In this case, it is imperative to have it checked by Vetec's service department before further use.

4. Basic settings

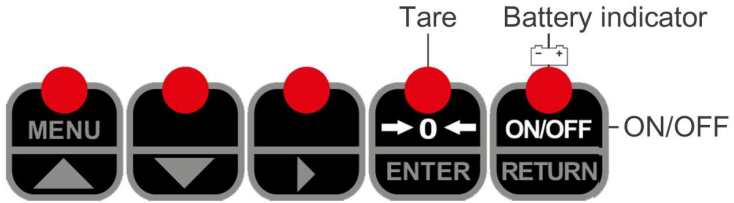

On / off

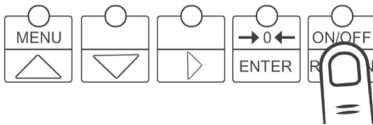

Press ON/OFF to turn on and off. Once pressed, the display will show the software version number for a few seconds. Then the untared value will show.

*The dynamometer will not automatically turn off if not used.

Tare function

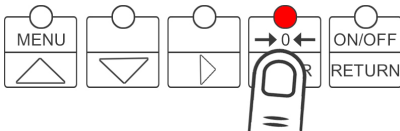

To activate the tare function press and hold →0← until the display shows 0 and the red button lights.

Press →0← to deactivate.

*The tare function will automatically deactivate when the dynamometer is turned off.

Low battery

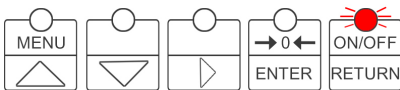

The tare function will automatically deactivate when the dynamometer is turned off.

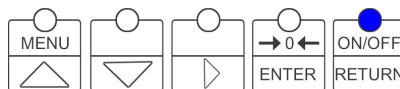

The battery indicator lights blue when charging. The blue light will turn off when fully charged.

5. Menu / Advanced settings

Menu / Advanced settings

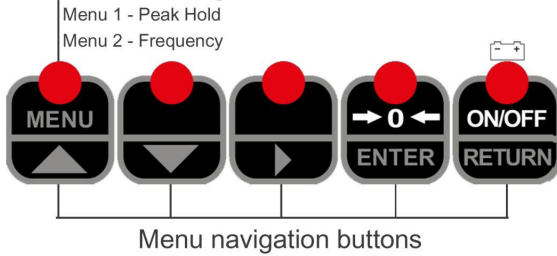

5.1. Peak hold (Menu 1)

Activate peak hold

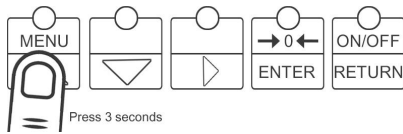

Press the ON/OFF button.
Press and hold MENU until the display shows **1**.
Select 1 (Menu 1) by pressing ENTER.
The display now shows **PEoFF** (Peak hold off).

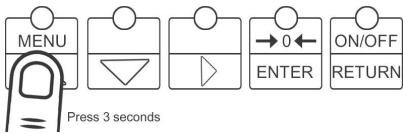

Press \triangle to go to **PE on** (Peak hold on).
Press ENTER to activate Peak hold.
The display now shows **1**.
Press RETURN to see the untared measurement.
Press RETURN to return to measurement.

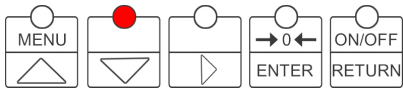

When peak hold is activated, the second button lights up red.
Lift a load and the display will “freeze” at the highest measurement recorded.

*Peak Hold is as default off.

Repeat lift

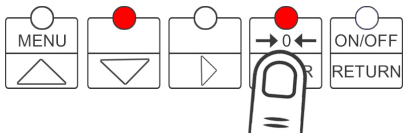

Press and hold $\rightarrow 0 \leftarrow$ until the display shows **0**.
Lift a load.
The display will “freeze” at the highest measurement recorded.

Repeat the above if needed.

Deactivate peak hold

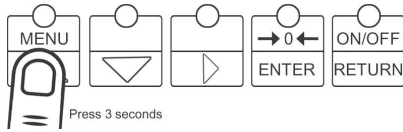

Press and hold MENU until the display shows **1**.
Select 1 by pressing ENTER.
The display now shows **PE on**.
Press **▽** until the display shows **PEoFF**.
Press ENTER to turn off Peak Hold.
Press RETURN to go to default settings.

*Peak hold will not deactivate when the dynamometer is turned off.

5.2 Operating multiple dynamometers in the same area (menu 2)

Menu 2 is used when operating multiple dynamometers with wireless displays in the same area. To avoid interference each set of dynamometer and wireless display can be set to operate on its own channel. In menu 2 it is possible to choose between 99 different channels.

Activate menu 2 on the dynamometer

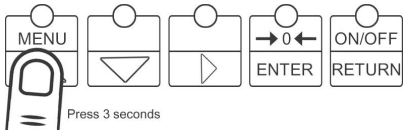

Press the ON/OFF button.
Press and hold MENU until the display shows **1**.
Press **△** to go to **2** (Menu 2).
Select **2** by pressing ENTER.

Selecting a channel on the dynamometer

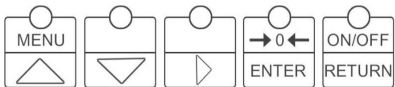

The display shows the default channel.
The first digit is blinking which means that it can be changed using the arrows.
Choose between 99 frequencies.
Select a channel by pressing ENTER.
Press RETURN to go back to weighing.

*Repeat the above on another dynamometer and select a different channel.

Activate menu 2 on the handheld display

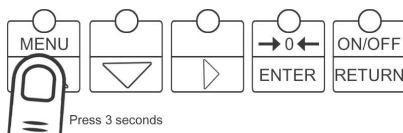

Press the ON/OFF button.
Press and hold MENU until the display shows **1**.
Press **△** to go to **2** (Menu 2).
Select **2** by pressing ENTER.

Activate beep function

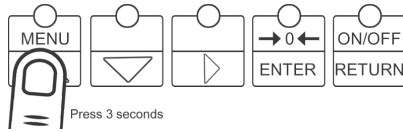

Press and hold **MENU** until the display shows 1.
 Select **3** by pressing **ENTER**.
 Use arrows to type in load limit in kg.
 Press **ENTER** to save.
 Press **RETURN** to go to default settings.

*Beep-function is only functional when connected to handheld display

Selecting a frequency on the handheld display

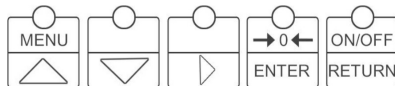

The display shows the default channel.
 The first digit is blinking which means that it can be changed using the arrows.
 Select the channel that corresponds to the channel of the V-LINK you want to operate.
 Press **ENTER** to select channel.

Press **RETURN** to go back to weighing.

*The channel settings will remain when the dynamometer and display are turned off.

*The channel is as default set as the last two digits of your V-LINK serial number.

6.. FAQ

Anomalies	Possible causes	Corrective actions
The device does not turn on	Discharged batteries	Charge the battery
	Electronics defective	Contact Vetec's service department
Display shows an incorrect value	More than 1 year since last calibration	Re-calibrate at Vetec service department
	Malfunction of electronics	Reset: Turn off and on and retest
	Has been overloaded	Contact Vetec's service department
Display value is not reset to 0	Has not been reset	Press →0←
	Has been overloaded	Contact Vetec's service department.

7. Charging

V-LINK is charged using a standard high quality USB charger. Always on stock at Vetec or available in any store.

Charge the dynamometer in your car, connected to your computer or using a wall charger.

As the charger is not waterproof charging the unit in a safe dry place is recommended. Place the dynamometer on a stable surface and make sure it is turned off. Plug in and charge up using the USB port on the rear of the dynamometer. Charge temperature 0°C to 45°C. A fully discharged battery takes up to 6 hours to recharge.

8. Service, repairs and maintenance

To prevent damage to the dynamometer, make sure that repairs and recalibration are carried out by qualified personnel.

It is recommended that recalibration and repairs are done at Vetec's service department located in Denmark or by authorized partners. Contact Vetec's service department for further information.

When you return a dynamometer for repair, make sure to always include the invoice number or the delivery note along with a description of the problem.

8.1. Battery replacement

The battery indicator blinks when it needs to be replaced. It is recommended to purchase the battery replacement kit that includes a Li-on battery and a new foil.

- Remove the foil.
- Use a suitable screwdriver to remove the battery cover.
- Replace the battery with a new battery.
- Put the battery cover back on and tighten the screws so that the cover is flush with the edge of the battery case. Ensuring that it is in correct position.
- Replace the foil with a new foil. This will ensure that the device is waterproof.

8.2. Regulatory audit / recalibration

V-LINK dynamometers are as standard supplied with a certificate of test and calibration which is valid for one (1) year.

The certificate indicates the values obtained during the adjustment. A new certificate of test and calibration will be issued every time a calibration is conducted.

An annual check of each device is recommended.

9. Maintenance

V-link requires no maintenance except regular cleaning after each use.

- Wipe off moisture or dust using a slightly damp, clean cloth.
- Cover the exterior with a thin layer of oil, e.g. WD 40. This will prevent rust.
- Keep the V-LINK in a dry, clean place.
- Never use cleaning solutions or high-pressure water.

10. Waste electrical and electronic equipment (WEEE)



A V-LINK must not be thrown away with general rubbish. Any disposal of the device must be carried out in accordance with the regulations in force in the country of use. Contact your local government's recycling or solid waste department for more information regarding the proper disposal of electronics in your region.

11. Warranty

Our products are warrantied for defects in materials or workmanship for a period of one (1) year from the date of purchase.

In the event of a defect during the warranty period, the dynamometer must be returned, with freight (and all duties and taxes) prepaid by the Buyer. Vetec A/S or the distributor will, according to their choice, repair or replace the defective unit.

The following faults are not covered by the warranty:

- Faults resulting from normal wear and tear.
- Parts of a consumable nature.
- Products that have been subject to unauthorized modifications.
- Faults resulting from incorrect installation or use.
- Damp or water damage exceeding the IP classification.

12. Vetec App

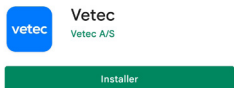

Find the app in Google Play store or Apple App Store

Login

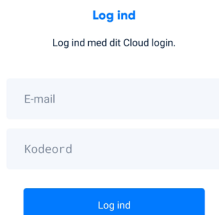

Login with your cloud id.

When you receive your dynamometer, you should receive an email with your login credentials (NB the sender is House of Code.

If you have not received login credentials, please contact us at post@vetec.dk and we will help you get started.

Connect dynamometer

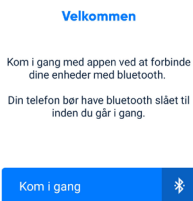

Turn on your dynamometer.

Make sure, that Bluetooth is turned on on your mobile and tap "Get started"

Pair dynamometer with phone



You should be able to see a dynamometer ready to connect.

When you press the serial number of the dynamometer your phone will automaticall be paired with the dynamometer and will be stored in your app for easy access.

Start measuring

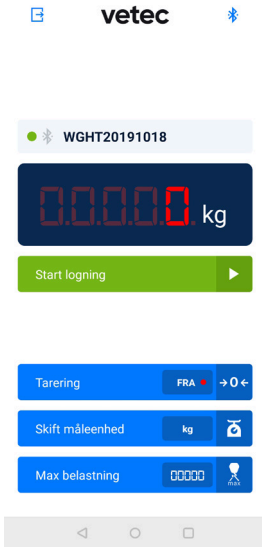

Now you are ready to start logging your measurements.

In the app you can change the taring, measurement unit and the max. load.

When you tap "Start logging" your measurement data will be automatically stores every 2 seconds.

All data will be available in our cloud service, which can be accessed at <https://appcms.dk>

Cloud service

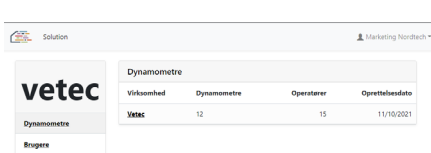

When you are logged in (same credentials as in the app) you will be able to see the connected dynamometer and the users, that are associated with your company.

If you click on a specific dynamometer, you will be able to see the logged measurements of the device.

Add new user

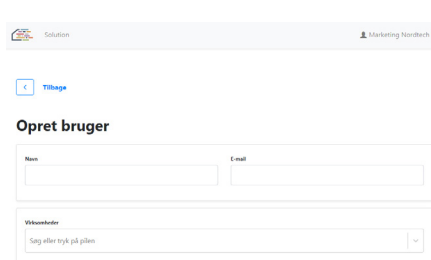

When you choose your company, you will find a button "Create User".

Here you can fill in the name and email on the person you wish to add.

Click on the arrow in the company field and choose your company.

Add an editor or a contributor

[Tilbage](#)

Opret bruger

Form for creating a user with fields for Name and Email, and a dropdown menu for selecting a role (Editor, Operator, Redaktør (Business Partner)).

Navn Email

Vilken bruger

- Editor
- Operator
- Redaktør (Business Partner)

Operator kan adgang til at logge ind i appen med samme login informationer.

When you click on your company name, you will have the option to add the new user as either “Editor” or “Contributer”.

User roles:

An editor can add new users + the same options as an operator have.

A contributor can use the dynamometer and log measurements and access the measurements in appcms.

