

GB Instruction for use  
DK Brugsanvisning

## POWERTEX Chain Block PCB-S2

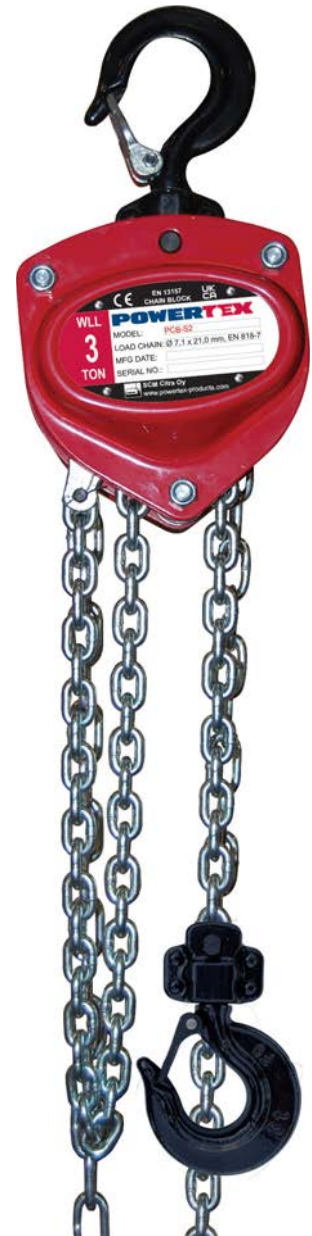

User Manual



## POWERTEX Chain Block PCB-S2 0,25 – 10 ton Instruction for use (GB) (Original instructions)

Read through these user instructions carefully before using the chain block. Improper operation may lead to hazardous situations!

### General safety provisions

- Only to be used by trained operator.
- Do not use in explosive or corrosive environment.
- Temperature range: -10°C up to +50°C.
- Check the function of the chain block before use. See "Daily checks" on page 3.
- Full function of the brake system can only be secured at a minimum load of 30 kg for capacities (WLL) up to 1 ton, and for capacities (WLL) above 1 ton, the minimum load to be greater than 3% of the rated capacity (WLL).
- Do not exceed the maximum load.
- Handle the chain block with care. Do not throw the block about or let it fall to the ground.
- Do not use the chain block for welding work where it is exposed to welding spatter or current.
- The chain block must not be used for lifting persons.

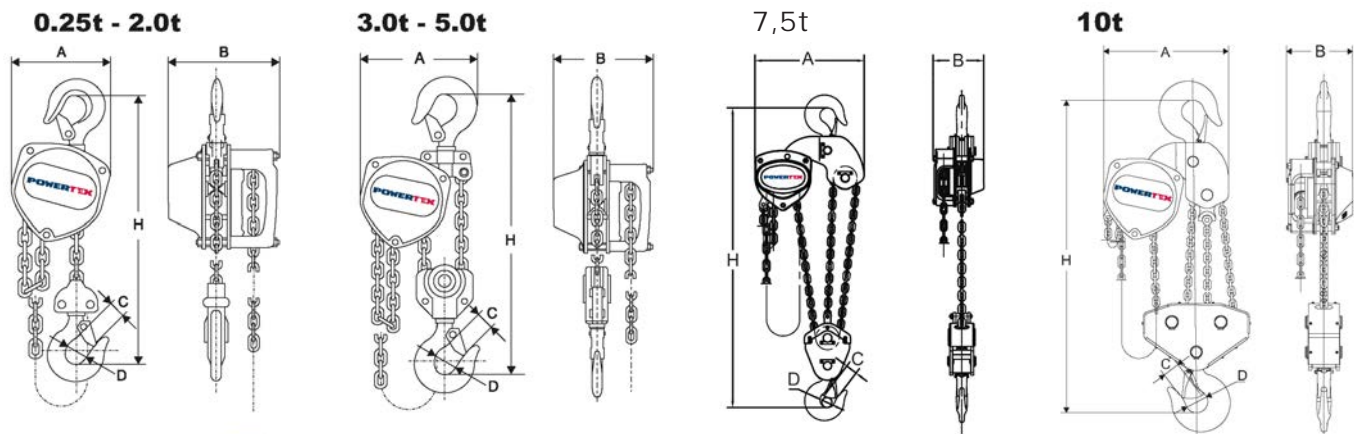

### Data

Model	WLL (ton)	Hand force max. (kg)	Load chain (mm)	Number of falls	Hand chain (mm)	Weight* (kg)
PCB-S2/250KG	0,25	23,5	4,0 x 12,0	1	5,0 x 23,7	5,9
PCB-S2/500KG	0,5	24,9	5,0 x 15,0	1	5,0 x 23,7	9,8
PCB-S2/1000KG	1	28,4	6,3 x 19,0	1	5,0 x 23,7	11,7
PCB-S2/2000KG	2	34,3	8,0 x 24,0	1	5,0 x 23,7	18,9
PCB-S2/3000KG	3	34,3	7,1 x 21,0	2	5,0 x 23,7	28,9
PCB-S2/5000KG	5	37,2	9,0 x 27,0	2	5,0 x 23,7	37,1
PCB-S2OLP/500KG	0,5	24,9	5,0 x 15,0	1	5,0 x 23,7	9,8
PCB-S2OLP/1000KG	1	28,4	6,3 x 19,0	1	5,0 x 23,7	11,7
PCB-S2OLP/2000KG	2	34,3	8,0 x 24,0	1	5,0 x 23,7	18,9
PCB-S2OLP/3000KG	3	34,3	7,1 x 21,0	2	5,0 x 23,7	28,9
PCB-S2OLP/5000KG	5	37,2	9,0 x 27,0	2	5,0 x 23,7	37,1
PCB-S2OLP/7500KG	7,5	36,8	9,0 x 27,0	3	5,0 x 23,7	50,0
PCB-S2OLP/10000KG	10	40,0	9,0 x 27,0	4	5,0 x 23,7	92,8
PCB-S2BK/500KG	0,5	24,9	5,0 x 15,0	1	5,0 x 23,7	9,8
PCB-S2BK/1000KG	1	28,4	6,3 x 19,0	1	5,0 x 23,7	11,7

\* With standard 3m lifting height. OLP = Overload Protection. BK = Blackline.

### Dimensions

WLL ton	A mm	B mm	C mm	D mm	H min. mm
0,25	108	106	20	30	260
0,5	130	128	22	34	280
1	150	145	26	39	330
2	185	175	35	49	385
3	220	158	37	50	510
5	255	183	43	60	615
7,5	430	189	47	67	690
10	360	183	47	65	820

Safety factor: 4:1.

Dynamic test coefficient: WLL x 1,5.

Generally according to EN 13157.

**Function**

The load hook is raised or lowered by pulling on the hand chain.  
 The load will remain where it is when the hand chain is released because of the effective reaction brake.  
 Max. hand force need to be respected to avoid overloading of the hoist.

The Over Load Protection (OLP) versions are additionally equipped with an overload protection device that will limit the force that can be applied using the hand chain.

If the OLP device is activated the hand chain will rotate but the hoist will not continue to lift, only lowering is possible.  
 The overload protection device is adjusted in the factory to approx. 1,3 x WLL and the device normally don't need to be adjusted.

**Suspension of chain block**

Suspend the block from an eye, shackle, girder trolley etc. with sufficient load capacity. With the chain tightened, both hooks must be vertically aligned.



**NB!** No bending stresses may be applied to block, hooks or load chain.

**Raising/lowering**

Only use straps and slings of sufficient load capacity. Check that the load is not anchored to the floor/ground or is otherwise fixed before making the lift. Ensure that the load chain hangs vertically and has no kinks. The hand chain must also be in good condition and easily accessible. The load is raised or lowered by pulling the hand chain in either direction.

**Warning:** Do not overload the brake by prolonged lowering. It may cause brake function to fail.

**Warning:**

- Only hand power from a single person is permitted on the hand chain. If the chain feels too heavy, use a bigger chain block or reduce the load.
- Make sure no-one stands beneath a hanging load.
- Do not step onto a hanging load.
- Do not raise or lower so far that the load hook hits the block housing.
- The chain block must not be used for pulling loads.
- The block must not be subjected to dynamic stresses, for example where a load connected to the block is launched from a height.
- Do not leave a block with a suspended load unattended.

**Attachment of loads**

Check the equipment before use. Improper attachment of loads can be highly dangerous (see Figs. 2 a – 2 e).

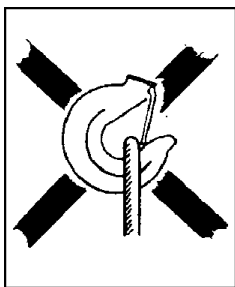

**Fig 2 a**  
 The sling is applying load to the hook tip

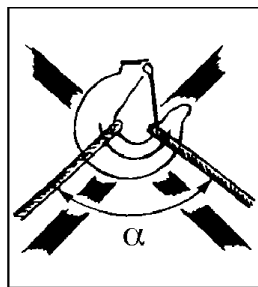

**Fig 2 b**  
 Excessive top angle on sling!  
 $\alpha$  max. 60°

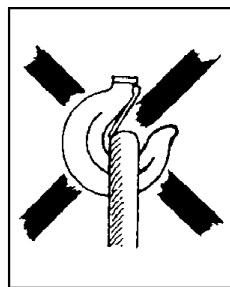

**Fig 2 c**  
 Hook latch obstructed

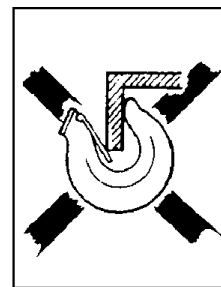

**Fig 2 d**  
 Hook tip subject to additional bending stress

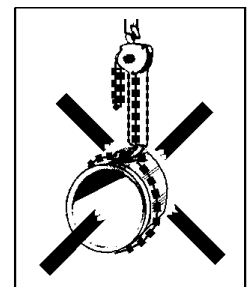

**Fig 2 e**  
 Load chain must not be used as a sling

**Multiple lifting**

Multiple lifting entails special risks. This is when two or perhaps more hoists are used simultaneously for the same load. Danger to persons and material damage can arise due to dynamic stresses and uneven load distribution causing individual hoists to become overloaded. A competent person with experience in multiple lifting must therefore supervise this type of lifting tasks.

The total weight of the target object and its load distribution must be known or calculated.

For a variety of reasons, the centre of gravity can be difficult to determine, and thus so will the distribution of the load each chain hoist must bear. In cases where heavy, bulky loads must be handled and it is not possible to estimate all factors correctly, the working load limit (WLL) of each chain hoist must be reduced by at least 25%.

**Daily checks**

After every working day on which the chain block has been used, the following should be checked:

- Is the chain block deformed or otherwise damaged? Are any parts missing?
- Is any deformation or other damage visible on the suspension device (eye, shackle, bolt, trolley etc.)?
- Are the hooks intact or have any hooks opened? Are the hook latches correct and functional?
- Wipe down the chain block and oil the load chain as required.
- The load chain must be undamaged, i.e. no signs of wear and no deformed or otherwise damaged links.
- The load chain must not be kinked or twisted. With two-fall or multi-fall chain blocks there is a risk of the chain twisting if the bottom hook assembly ends up looped through the chain sling – usually during refitting or moving the chain block between work stations. See Fig 3.
- The hand chain must also be in good condition.
- The brake function must be intact.

In the event of faults or failures, the block must be repaired and carefully checked by a specialist before reuse.

**Continuous maintenance - lubrication**

Oil the hook latches and bearings. Grease the pawl and ratchet and also the gear. Lubrication must be sparingly and carefully applied so no grease gets on the brake disk. Oil the load chain for longer life.

## Periodic checks

Periodic checks are normally carried out yearly to detect and remedy any faults. If required (e.g. high frequency of use), more frequent checks may be carried out. See "Checklist for periodic checks". Measure hooks and chain to detect any changes in shape.

### Checks on load hook (see Fig. 4 and Table 1)

Opening dimension C on the hooks is important. A hook with too large a maximum dimension has been exposed to overloading or overheating. It therefore does not have the necessary load capacity. The hooks may also have been exposed to long-term wear (dimension K).

Hooks must be discarded and replaced if:

- The maximum C value is exceeded (according to Table 1)
- The minimum K value falls short (according to Table 1)
- The hook shows signs of cracking
- The hook is deformed or otherwise damaged

Defective hooks must be replaced before using the chain block again.

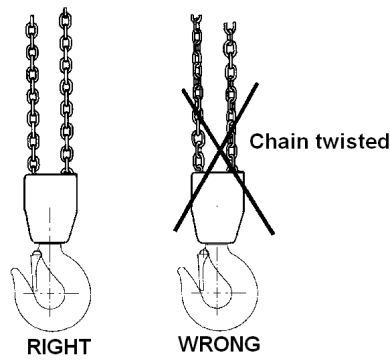

Fig. 3 The chain must not be twisted

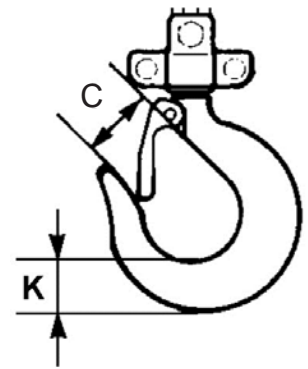

Fig. 4 Load hook

Table 1 Load hook

WLL t	0,25	0,5	1	2	3	5	7,5	10
Model	PCB-S2	PCB-S2	PCB-S2	PCB-S2	PCB-S2	PCB-S2	PCB-S2	PCB-S2
Dimension C nominal mm	24	25,5	30	38,5	41,5	47	57	55
Dimension C max mm	26,4	28,0	33	42,3	45,5	51,7	62,7	60,5
Dimension K nominal mm	15	19	25	33,5	39	44,5	65,5	62
Dimension K min mm	13,5	17,1	22,5	30,2	35,1	40,0	59	55,8

### Checks on load chain (see Fig. 5 and Table 2)

Inspect the load chain over its whole length to detect any deformed or otherwise damaged links. Make a check measurement of suspect links. Measure the worn areas Also, every 300 mm (normally), make check measurements of the internal length of 5 links (pitch dimension 5xP – according to Table 2).

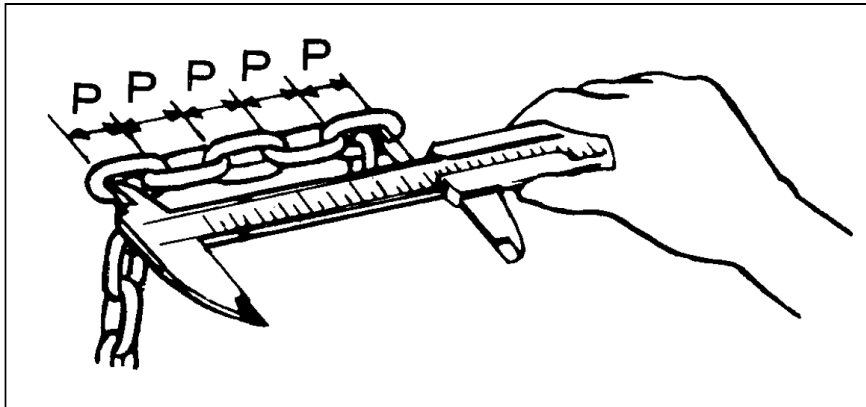

Fig 5 Checking load chain dimensions

Table 2 Load chain

Max. load t	0,25	0,5	1	2	3	5	7,5	10
Model	PCB-S2	PCB-S2	PCB-S2	PCB-S2	PCB-S2	PCB-S2	PCB-S2	PCB-S2
Link diameter nominal mm	4,0	5,0	6,3	8,0	7,1	9,0	9,0	9,0
Link diameter min. mm	3,6	4,5	5,7	7,2	6,4	8,1	8,1	8,1
Pitch dimension (5xP) nominal mm	60,0	75,0	95,0	120,0	105,0	135,0	135,0	135,0
Pitch dimension (5xP) max. mm	61,8	77,2	98,0	123,5	108,1	139,0	139,0	139,0

The load chain must be discarded and replaced if:

- cracks are detected on any link
- any link is deformed or otherwise damaged
- The minimum value of any link's diameter falls short
- the maximum value of the pitch dimension is exceeded at any point
- the chain is damaged by overheating or has been affected by weld splatter

Load chains must **not** be repaired – they must be replaced by new chain. If it is desired to lengthen the chain, it must be replaced by a new and longer chain.

Replacement of the chain shall be performed professionally by an authorized repairer and the chain must meet the requirements stated in the standard EN 818-7, Grade T from the following manufacturers: Chaineries Limousines, Pewag, Thiele or Rud.

## Repairs

The chain block must not be modified. Repairs must be carried out by specialists. Damaged parts must only be replaced with original Powertex Parts. Order them through your dealer.

## EC Declaration of conformity

SCM Citra OY

Asessorinkatu 3-7

20780 Kaarina, Finland

www.powertex-products.com

hereby declares that the POWERTEX product as described above is in compliance with EC Machinery Directive 2006/42/EC & EN 13157.

## UK Declaration of conformity

SCM Citra OY

Asessorinkatu 3-7

20780 Kaarina, Finland

www.powertex-products.com

hereby declares that the POWERTEX product as described above is in compliance with the Supply of Machinery (Safety) Regulations 2008 & BS EN 13157.

## Checklist for periodic checks (normally yearly – more frequently if necessary)

Daily	Yearly	Inspection items	Inspection method	Note
<b>Labels</b>				
X	X	Rating plate	Visual	If the plate is hard to read - replace it
<b>Function</b>				
X	X	Raising and lowering function	Test without load	A low snapping noise should be audible
-	X	Raising and lowering function	Test with rated weight for min 300 mm	Load chain sprocket and chain work well together. Brake works. Hand pulling on the hand chain feels even and not too heavy
<b>Hooks</b>				
X -	- X	Hook opening	Visual Measurements	Looks normal See Fig. 4 and Table 1
X	X	Deformation	Visual	No visible deformation
X	X	Hook bearing	Visual	No abnormal play
X -	- X	Wear, cracks, deformation and corrosion	Visual Measurements	No visible damage See Fig. 4 and Table 1
X	X	Hook latches	Visual	Works, spring undamaged
<b>Load chain</b>				
X -	- X	Pitch	Visual Measurement	Looks normal. Measure in case of doubt See Fig. 5 and Table 2
X -	- X	Wear	Visual Measurement	Looks problem-free. Measure in case of doubt See Fig. 5 and Table 2
X	X	Deformation	Visual	No deformation. Measure in case of doubt
X	X	Cracks etc.	Visual	No cracks
X	X	Rust	Visual	No rust
<b>Housing</b>				
X	X	Frame	Visual	No deformation and no rust
X	X	Gearbox	Visual	No deformation
-	X	Gears	Visual after dismantling	No serious wear or fractures
-	X	Load chain sprocket	Visual after dismantling	No serious wear or cracks. No fractures or deformation
-	X	Hand chain sprocket	Visual	No serious wear or cracks. No fractures or deformation
-	X	Bearings	Visual, testing	No damage, smooth running
<b>Screws</b>				
X	X	Screws, nuts, rivets, cotters etc.	Visual	Must not be missing. Tighten loose items. Replace as necessary
<b>Brake</b>				
-	X	Brake disk	Visual	Replace if worn
-	X	Brake screw	Visual	No serious wear
-	X	Pawl and ratchet	Visual	Replace worn parts. Carefully lubricate with grease

## POWERTEX kædetalje PCB-S2 0,25 - 10 ton Brugsanvisning (DK)

Læs denne brugsanvisning, før kædetaljen tages i brug. Forkert brug kan medføre fare!

### Generelle sikkerhedsanvisninger

- Må kun betjenes af uddannet operatør.
- Må ikke anvendes i eksplosive eller ætsende miljøer.
- Arbejdstemperatur: -10°C op til +50°C.
- Kontrollér kædetaljens funktion før brug. Se: "Daglig kontrol" på side 7.
- Belast ikke med mere end maks.-lasten.
- Fuld funktion af bremsesystemet kan kun sikres ved en minimum belastning på 30 kg, for kapaciteter (WLL) op til 1 ton, og for kapaciteter (WLL) over 1 ton, skal minimum belastningen være større end 3% af den nominelle kapacitet (WLL).
- Håndtér kædetaljen med forsigtighed. Taljen må ikke kastes med eller slæbes.
- Brug ikke kædetaljen ved svejsearbejder, hvor den kan blive udsat for svejsestænk eller svejsestrøm.
- Kædetaljen må ikke bruges til personløft.

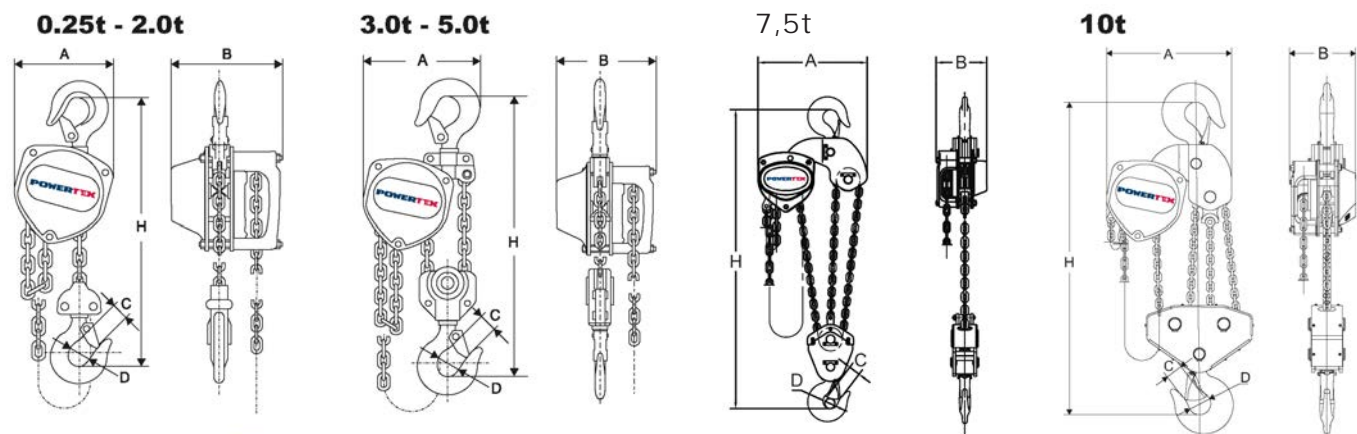

### Data

Model	WLL ton	Håndkraft maks. (kg)	Lastkæde (mm)	Fald	Håndkæde (mm)	Vægt* (kg)
PCB-S2/250KG	0,25	23,5	4,0 x 12,0	1	5,0 x 23,7	5,9
PCB-S2/500KG	0,5	24,9	5,0 x 15,0	1	5,0 x 23,7	9,8
PCB-S2/1000KG	1	28,4	6,3 x 19,0	1	5,0 x 23,7	11,7
PCB-S2/2000KG	2	34,3	8,0 x 24,0	1	5,0 x 23,7	18,9
PCB-S2/3000KG	3	34,3	7,1 x 21,0	2	5,0 x 23,7	28,9
PCB-S2/5000KG	5	37,2	9,0 x 27,0	2	5,0 x 23,7	37,1
PCB-S2OLP/500KG	0,5	24,9	5,0 x 15,0	1	5,0 x 23,7	9,8
PCB-S2OLP/1000KG	1	28,4	6,3 x 19,0	1	5,0 x 23,7	11,7
PCB-S2OLP/2000KG	2	34,3	8,0 x 24,0	1	5,0 x 23,7	18,9
PCB-S2OLP/3000KG	3	34,3	7,1 x 21,0	2	5,0 x 23,7	28,9
PCB-S2OLP/5000KG	5	37,2	9,0 x 27,0	2	5,0 x 23,7	37,1
PCB-S2OLP/7500KG	7,5	36,8	9,0 x 27,0	3	5,0 x 23,7	50,0
PCB-S2OLP/10000KG	10	40,0	9,0 x 27,0	4	5,0 x 23,7	92,8
PCB-S2BK/500KG	0,5	24,9	5,0 x 15,0	1	5,0 x 23,7	9,8
PCB-S2BK/1000KG	1	28,4	6,3 x 19,0	1	5,0 x 23,7	11,7

\* Med standard 3 m løftehøjde. OLP = Overlastsikring. BK = Blackline.

### Dimensioner

WLL ton	A (mm)	B (mm)	C (mm)	D (mm)	H min. (mm)
0,25	108	106	20	30	260
0,5	130	128	22	34	280
1	150	145	26	39	330
2	185	175	35	49	385
3	220	158	37	50	510
5	255	183	43	60	615
7,5	430	189	47	67	690
10	360	183	47	65	820

Sikkerhedsfaktor: 4:1.  
Dynamisk test-koefficient: WLL x 1,5.  
Generelt i henhold til EN 13157.

## Funktion

Lastkrogen løftes eller sænkes ved at trække i styrekæden.

Takket være en effektiv lasttrykbremse bliver lasten hængende, selvom man slipper styrekæden.

Maks. Håndkraft skal respekteres for at undgå overbelastning af hejsen.

OLP-versionerne (Overlastsikring) er desuden udstyret med en overlastsikring, der begrænser den kraft, der kan påføres ved hjælp af håndkæden.

Når OLP-enheden aktiveres ved overbelastning, vil håndkæden rotere, men taljen fortsætter ikke med at løfte, kun sænkning er mulig.

Overlastsikringen justeres fra fabrikken til ca. 1,3 x WLL og enheden skal normalt ikke justeres.

## Ophængning af kædetaljen

Taljen ophænges i øsken, sjækkel, løbekat på bjælke osv. med tilstrækkelig bæreevne. Når kæden er strammet op, skal de to kroge være vertikalt i linje med hinanden.



**OBS!** Hverken talje, kroge eller lastkæde må udsættes for bøjebelastning.

## Løft/sænkning

Brug kun stropper og løkker med tilstrækkelig bæreevne. Kontrollér, at lasten ikke er forankret i gulvet/jorden eller på anden vis har sat sig fast, før den løftes. Sørg for, at lastkæden hænger vertikalt og ikke har dannet kinker. Styrekæden skal også sidde ordentligt og lettilgængeligt. Lasten løftes hhv. sænkes, når man trækker i styrekæden i den relevante side.

Overbelast ikke bremsen ved langvarig sænkning. Det kan medføre, at bremsefunktionen mislykkes

## Advarsel!

- Styrekæden må kun betjenes ved håndkraft! Hvis det føles for tungt, skal man vælge en større kædetalje eller reducere lasten!
- Sørg for, at der ikke opholder sig personer under hængende last!
- Stå ikke på hængende last!
- Der må ikke løftes og sænkes for langt, da lastkrogen i så fald kan risikere at ramme taljehuset!
- Kædetaljen må ikke bruges til træk af last.
- Taljen må ikke udsættes for dynamiske påvirkninger, f.eks. ved at en last, der er fastgjort til taljen, puffes ud oppefra!
- Efterlad ikke taljen med hængende last uden opsyn!

## Fastgørelse af last

Kontrollér udstyret før brug. Forkert fastgørelse af last kan være meget farligt (se fig. 2 a – 2 e).

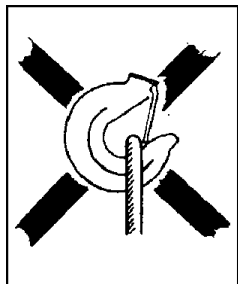

**Fig 2 a**  
Løkken belaster krogens spids!

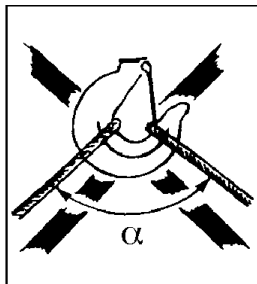

**Fig 2 b**  
For stor topvinkel på løkken!  
 $\alpha$  max 60°

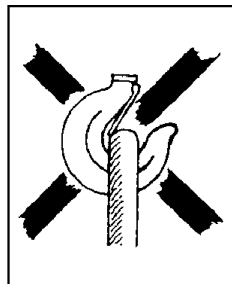

**Fig 2 c**  
Krogens låsepæl blokeret!

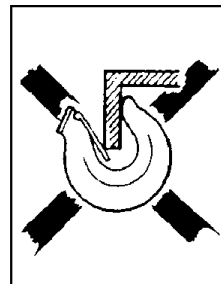

**Fig 2 d**  
Krogens spids desuden udsat for bøjebelastning!

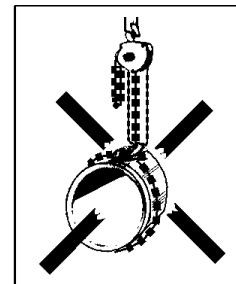

**Fig 2 e**  
Lastkæden må ikke bruges som løkke!

## Samløft

Samløft medfører særlige risici. Det er, når to eller evt. flere taljer bruges samtidigt til den samme last. Der kan opstå fare for personer og risiko for materielle skader som følge af dynamiske påvirkninger og ujævn lastfordeling, så en (eller flere) af taljerne bliver overbelastet. Samløft skal derfor foregå under ledelse af en kvalificeret person, der har den fornødne erfaring.

Den totale vægt af målobjektet og dets last fordeling skal være kendt eller beregnes.

Af forskellige grunde kan tyngdepunktet være vanskeligt at afgøre, og dermed også fordelingen af belastningen hver kædetalje skal bære. I tilfælde, hvor tunge, uhelderlige byrder skal håndteres, og det er ikke muligt at estimere alle faktorer korrekt, skal hver kædetaljes maksimale WLL reduceres med mindst 25%.

## Daglig kontrol

Efter hver arbejdsdag, hvor kædetaljen har været anvendt, skal følgende kontrolleres:

- Er kædetaljen blevet deform, eller har den fået andre skader? Mangler der nogen dele?
- Kan man se deformationer eller andre skader på ophængningsanordningerne (øsken, sjækkel, bolt, løbekat osv.)?
- Er krogene intakte, eller er en af krogene åbnet? Er krogenes låsepæle fejlfri og funktionsdygtige?
- Kædetaljen aftørres og lastkæden smøres ved behov.
- Lastkæden skal være intakt, dvs. den må ikke være slidt eller have deforme eller på anden vis beskadigede kædeled.
- Lastkæden må ikke have kinker eller være snoet. Ved 2- eller flerparts taljebud er der risiko for, at kæden kan blive snoet, ved at underblokken kommer til at smutte gennem kædesløjfen – typisk ifm. ommontering eller flytning af kædetaljen mellem forskellige arbejdssteder. Se fig. 3.
- Styrekæden skal også sidde ordentligt.
- Bremsefunktionen skal være intakt.

I tilfælde af fejl eller defekter skal taljen repareres og omhyggeligt kontrolleres af en tekniker, før den tages i brug igen.

## Løbende vedligeholdelse – smøring

Smør krogens låsepæle og lejer. Låsehage og -hjul samt gear smøres med fedt. Der skal smøres sparsomt og forsigtigt, så der ikke kommer smøremiddel på bremsekiven. Smør lastkæden – det forlænger dens levetid.

## Regelmæssig kontrol

Der skal foretages regelmæssig kontrol, som hovedregel en gang om året, så eventuelle dysfunktioner kan blive opdaget og afhjulpnet. Ved behov (f.eks. hvis brugsfrekvensen er høj) udføres kontrollen oftere. Se "Tjekliste for regelmæssig kontrol". Kroge og kæde måles for at kontrollere for eventuelle formændringer.

### Kontrol af lastkrog (se fig. 4 og tabel 1)

Krogens åbningsmål C er vigtigt. En krog, hvis maks.-mål overskrides, har været udsat for overbelastning eller opvarmning. Den har derfor ikke tilstrækkelig bæreevne. Krogene kan også have været udsat for langvarig slitage (mål K).

En krog skal kasseres og udskiftes med en ny, hvis:

- C-målets maks.-værdi overskrides (jf. tabel 1)
- Den angivne minimumsværdi for K-målet ikke overholdes (jf. tabel 1)
- Krogen har revner
- Krogen er deform eller på anden vis beskadiget

En defekt krog skal udskiftes, før kædetaljen tages i brug igen!

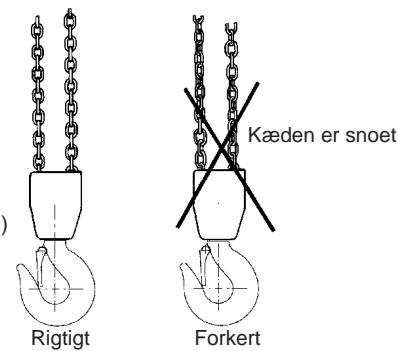

Fig. 3 Kæden må ikke være snoet

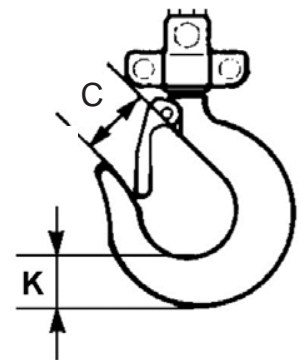

Fig. 4 Lastkrog

Tabel 1 Lastkrog

WLL t	0,25	0,5	1	2	3	5	7,5	10
Model	PCB-S2	PCB-S2	PCB-S2	PCB-S2	PCB-S2	PCB-S2	PCB-S2	PCB-S2
Dimension C nominel mm	24	25,5	30	38,5	41,5	47	57	55
Dimension C maks. mm	26,4	28,0	33	42,3	45,5	51,7	62,7	60,5
Dimension K nominel mm	15	19	25	33,5	39	44,5	65,5	62
Dimension K min mm	13,5	17,1	22,5	30,2	35,1	40,0	59	55,8

### Kontrol af lastkæde (se fig. 5 og tabel 2)

Efterse lastkæden i hele dens længde for at opdage evt. deforme eller på anden vis beskadigede kædeled. Suspekte kædeled skal kontrolmåles. Mål ved slidstederne. Kontrolmål også, for hver 300 mm (normalt), den indvendige længde af 5 kædeled (pitch 5xP, jf. tabel 2).

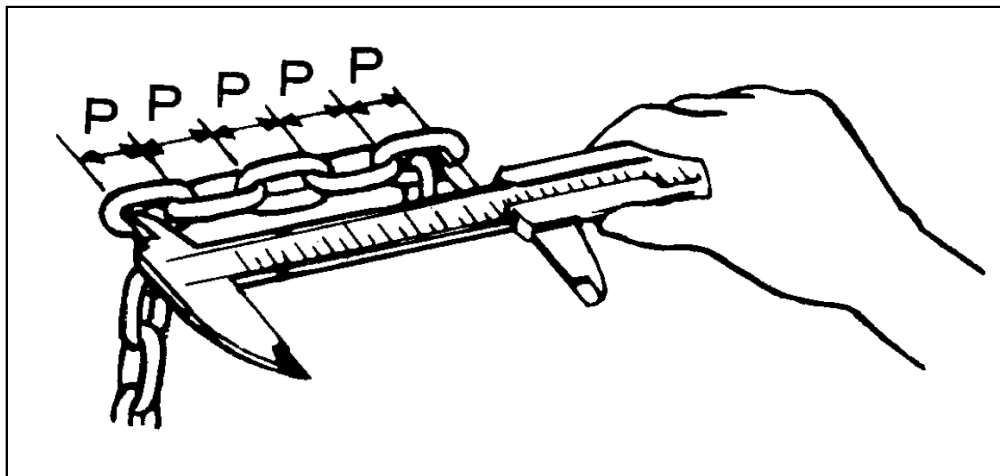

Fig. 5 Kontrolmåling af lastkæde

Tabel 2 Lastkæde

Maks. last ton	0,25	0,5	1	2	3	5	7,5	10
For model	PCB-S2	PCB-S2	PCB-S2	PCB-S2	PCB-S2	PCB-S2	PCB-S2	PCB-S2
Kædeleddiameter nominelt mm	4,0	5,0	6,3	8,0	7,1	9,0	9,0	9,0
Kædeleddiameter min. mm	3,6	4,5	5,7	7,2	6,4	8,1	8,1	8,1
Indvendig længde (5xP) nominelt mm	60,0	75,0	95,0	120,0	105,0	135,0	135,0	135,0
Indvendig længde (5xP) maks. mm	61,8	77,2	98,0	123,5	108,1	139,0	139,0	139,0

Lastkæden skal kasseres og udskiftes med en ny, hvis:

- der konstateres revner i et kædeled
- et kædeled er deformt eller på anden vis beskadiget
- den angivne min.-værdi for et kædeleds diameter ikke overholdes
- den maksimale pitch-værdi overskrides et eller flere steder
- kæden er beskadiget pga. opvarmning, eller hvis der er kommet svejsestænk på den

Lastkæden må **ikke** repareres – den skal udskiftes med en ny originalkæde. Hvis man ønsker en længere kæde, skal kæden udskiftes med en ny kæde, der er længere.



Udskiftning af kæden skal udføres professionelt af en autoriseret reparatør og kæden skal opfylde kravene i standarden EN 818-7, klasse T fra følgende producenter: Chaineries Limousines, Pewag, Thiele eller Rud.

### Reparationer

Kædetaljen må ikke ombygges. Reparationer skal udføres af en tekniker. Udskift kun beskadigede dele med originale Powertex reservedele. Bestilles hos forhandleren.

### Overensstemmelseserklæring

SCM Citra OY  
Asessorinkatu 3-7  
FI-20780 Kaarina  
Finland  
www.powertex-products.com

erklærer hermed, at POWERTEX-produktet som beskrevet ovenfor er i overensstemmelse med EC Maskindirektivet 2006/42/EF og EN 13157.

### Tjekliste for regelmæssig kontrol (normalt årligt – oftere ved behov)

Dagligt	Årligt	Kontrolpunkter	Kontrolmetode	Bemærk
<b>Mærkning</b>				
X	X	Typeskilt	Visuelt	Hvis typeskiltet er svært at læse, skal det udskiftes
<b>Funktion</b>				
X	X	Løfte- og sænkefunktion	Test uden last	Der skal høres en blid, klikkende lyd
-	X	Løfte- og sænkefunktion	Test med mærke-lasten for min. 300 mm	Kædehjul og kæde fungerer fint sammen. Bremsen fungerer. Styrekæde-håndkraften er jævn og ikke for stor
<b>Kroge</b>				
X	-	Krogenes åbning	Visuelt	Ser normalt ud
-	X		Mål	Se fig 4 og tabel 1
X	X	Deformation	Visuelt	Ingen synlig deformation
X	X	Krogenes lejer	Visuelt	Intet unormalt slør
X	-	Slitage, revner, deformation og korrosion	Visuelt	Ingen synlige skader
-	X		Mål	Se fig. 4 og tabel 1
X	X	Palkrog	Visuelt, test	Fungerer, fjederen ubeskadiget.
<b>Lastkæde</b>				
X	-	Indvendig længde	Visuelt	Ser normal ud. Foretag måling i tvivlstilfælde
-	X		Mål	Se fig. 5 og tabel 2
X	-	Slitage	Visuelt	Ser fejlfri ud. Foretag måling i tvivlstilfælde
-	X		Mål	Se fig. 5 og tabel 2
X	X	Deformation	Visuelt	Ingen deformation. Foretag måling i tvivlstilfælde
X	X	Revner m.m.	Visuelt	Ingen revner
X	X	Rust	Visuelt	Ingen rust
<b>Hus</b>				
X	X	Huset	Visuelt	Ingen deformation og ingen rust
X	X	Gearhus	Visuelt	Ingen deformation
-	X	Gear	Visuelt efter demontering	Ingen alvorlig slitage eller brud
-	X	Kædehjul	Visuelt efter demontering	Ingen alvorlig slitage eller revner. Ingen brud eller deformation
-	X	Styrekæde-hjul	Visuelt	Ingen alvorlig slitage eller revner. Ingen brud eller deformationer
-	X	Lejer	Visuelt, test	Uden skader, fungerer let
<b>Skruer</b>				
X	X	Skruer, møtrikker, nitter, splitter m.v.	Visuelt	Må ikke mangle. Løse skruer m.v. strammes. Udskiftes ved behov
<b>Bremse</b>				
-	X	Bremseskive	Visuelt	Slidt bremseskive udskiftes
-	X	Bremseskrue	Visuelt	Ingen alvorlig slitage
-	X	Låsehage og -hjul	Visuelt	Udskift slidte dele. Smøres forsigtigt med fedt.

## POWERTEX Chain Block PCB-S2 – Parts 0,25 t

When ordering parts, specify model, WLL, pos number, description and the quantity needed.

When ordering chain, also specify lifting height.

If the load chain has been damaged or worn out the load sheave probably has to be replaced.

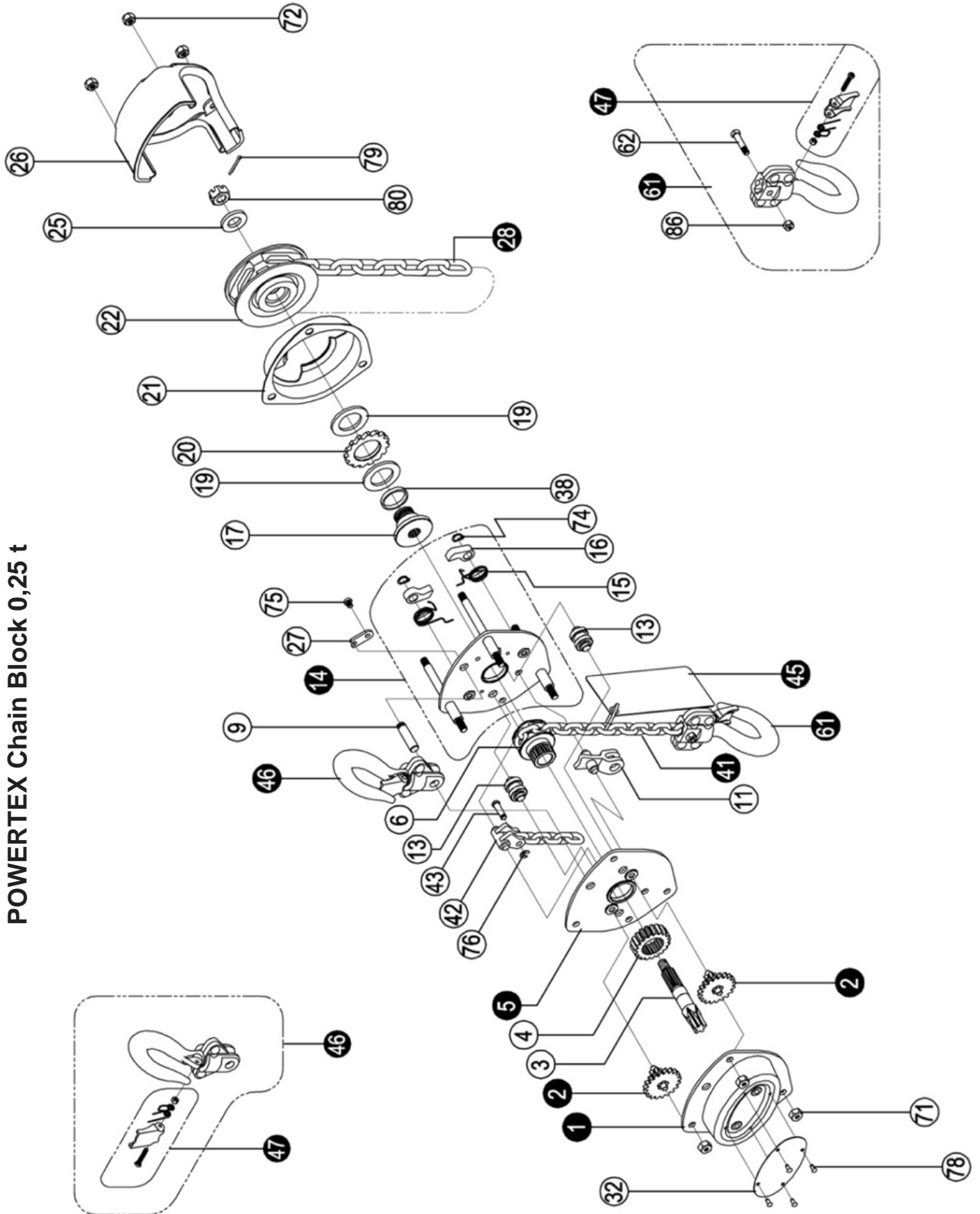

POWERTEX Chain Block 0,25 t

**Parts list 0,25 t**

<b>Pos</b>	<b>Description</b>
1	Gear cover assy
2	Disc gear assy
3	Drive shaft
4	Splined gear
5	Right side plate assy
6	Load chain sprocket
9	Top hook shaft
11	Chain stripper
13	Guide roller
14	Left side plate assy
15	Pawl spring
16	Pawl
17	Brake seat
19	Friction plate
20	Ratchet wheel
21	Brake cover
22	Hand chain wheel
25	Washer
26	Hand chain cover
27	Positioned plate
28	Hand Chain
32	Name plate
41	Load Chain
42	End anchor
43	End anchor pin
45	Warning plate assy
46	Top hook assy
47	Safety latch assy
61	Bottom hook assy
62	Bottom hook pin
71	Metal lock nut
72	Metal lock nut
74	Circlip
75	Cross head screw
76	Split retainer
78	Name plate
79	Split pin
80	Hexagon nut

## POWERTEX Chain Block PCB-S2 – Parts 0,5 – 5 t

When ordering parts, specify model, WLL, pos number, description and the quantity needed.

When ordering chain, also specify lifting height.

If the load chain has been damaged or worn out the load sheave probably has to be replaced

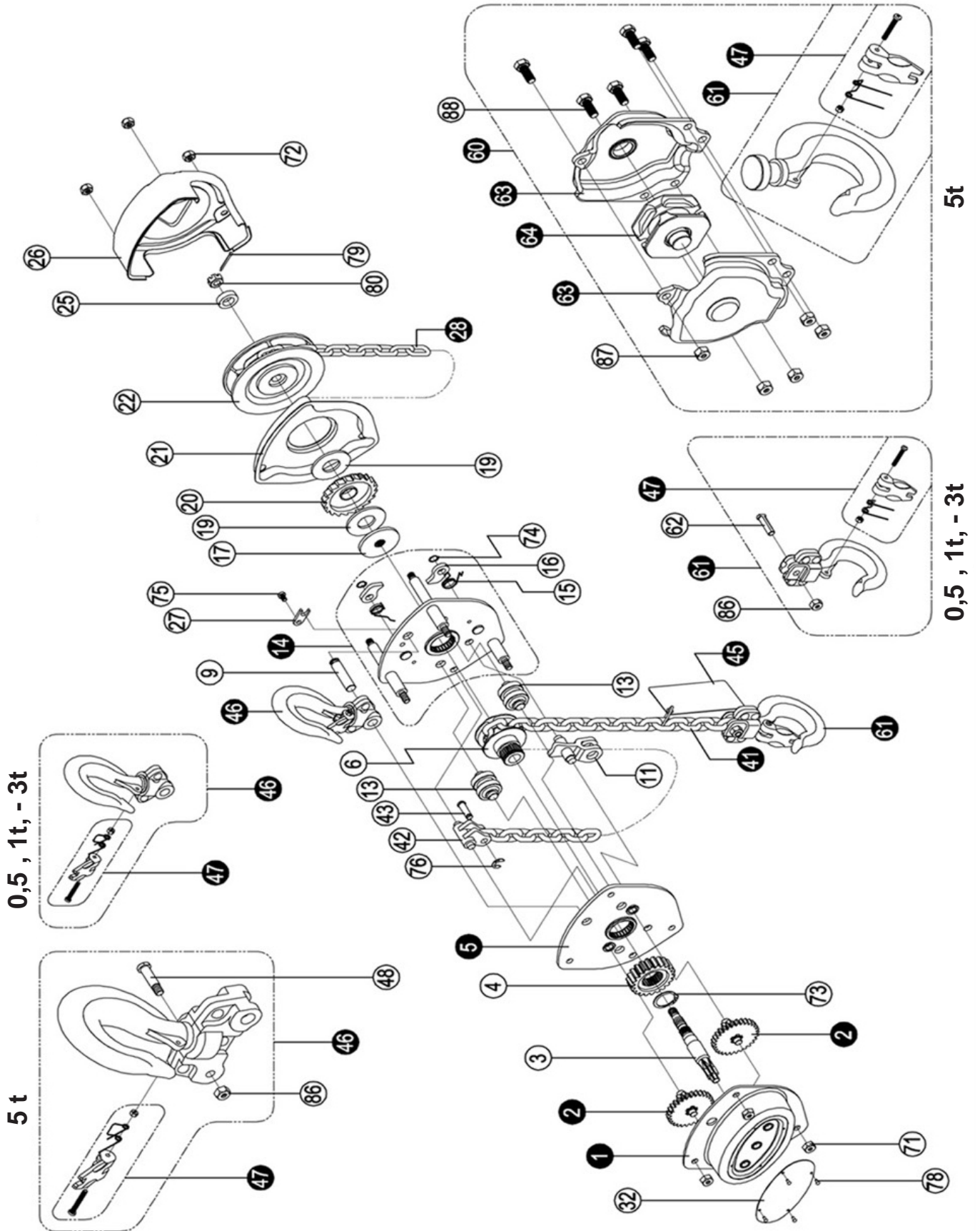

**Parts list 0,5 – 5 t**

<b>Pos</b>	<b>Description</b>
1	Gear cover assy
2	Disc gear assy
3	Drive shaft
4	Splined gear
5	Right side plate assy
6	Load chain sprocket
9	Top hook shaft
11	Chain stripper
13	Guide roller
14	Left side plate assy
15	Pawl spring
16	Pawl
17	Brake seat
19	Friction plate
20	Ratchet wheel
21	Brake cover
22	Hand chain wheel
25	Washer
26	Hand chain cover
27	Positioned plate
28	Hand Chain
32	Name plate
41	Load Chain
42	End anchor
43	End anchor pin
45	Warning plate assy
46	Top hook assy
47	Safety latch assy
48	Top hook pin
60	Bottom hook assy
61	Bottom hook assy
62	Bottom hook pin
63	Bottom hook connector assy
64	Idler sheave assy
71	Metal lock nut
72	Metal lock nut
73	Circlip
74	Circlip
75	Cross head screw
76	Split retainer
78	Name plate
79	Split pin
80	Hexagon nut
86	Metal lock nut
87	Metal lock nut
88	Bolt M10x25

## POWERTEX Chain Block PCB-S2 – Parts 7,5 t hooks. Parts for hoist body same as for 10 t

When ordering parts, specify model, WLL, pos number, description and the quantity needed.

When ordering chain, also specify lifting height.

If the load chain has been damaged or worn out the load sheave probably has to be replaced.

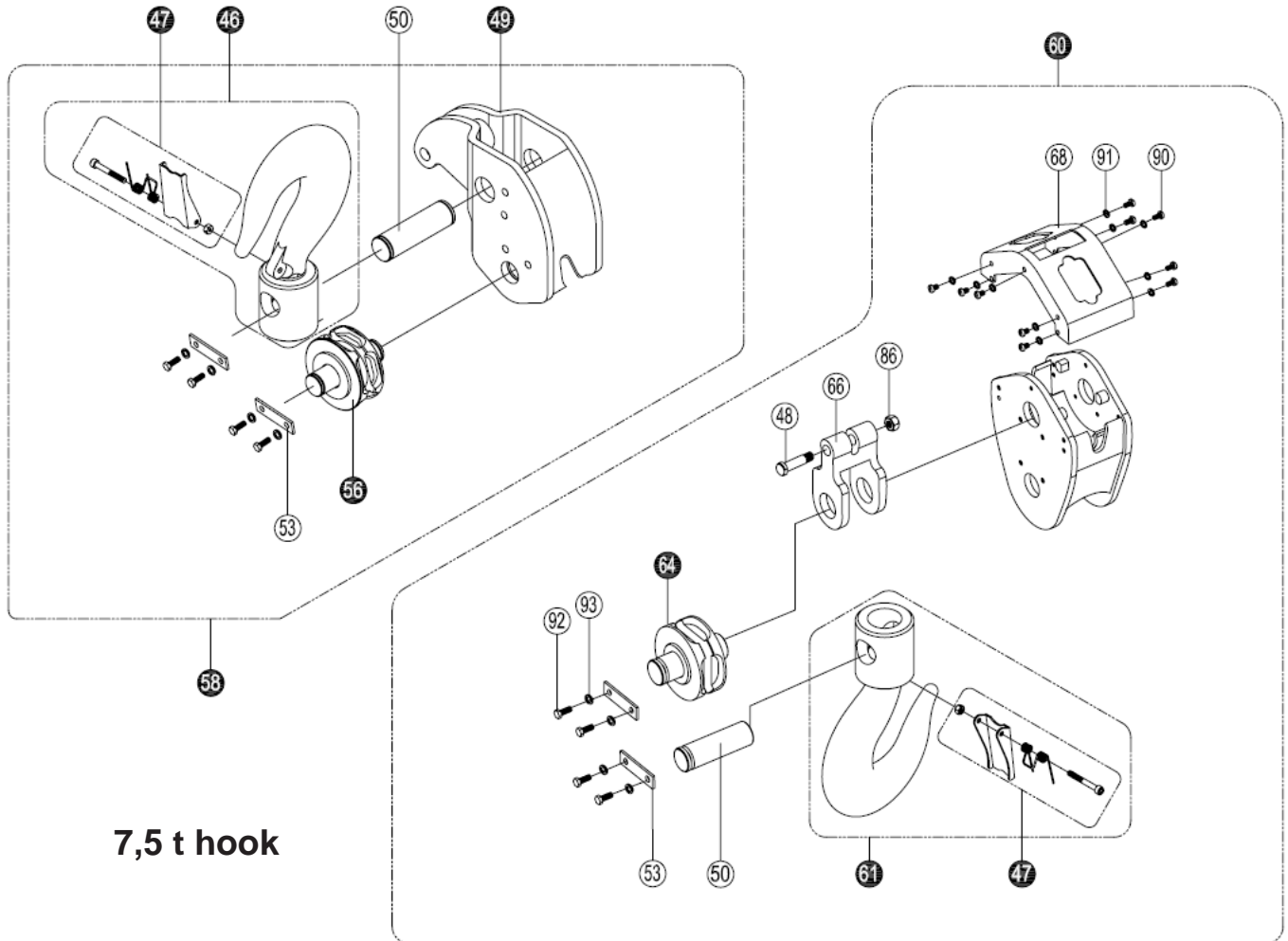

**7,5 t hook**

### Parts list hooks 7,5 t hook

Pos	Description
46	Top hook assy
47	Safety latch assy
48	Top hook pin
49	Top Hook connector
50	Shaft
53	Positioning plate
56	Top hook Idler sheave assy
58	Top Hook complete set
60	Bottom hook complete set
61	Bottom hook assy
64	Bottom hook Idler sheave assy
66	Chain holder
68	Protection cover
86	Metal lock nut M10
90	Screw
91	Spring washer
93	Spring washer
92	Bolt

**POWERTEX Chain Block PCB-S2 – Parts 7,5 t and 10 t  
(below hooks are for 10 t. See previous page for 7,5 t hooks)**

When ordering parts, specify model, WLL, pos number, description and the quantity needed.

When ordering chain, also specify lifting height.

If the load chain has been damaged or worn out the load sheave probably has to be replaced.

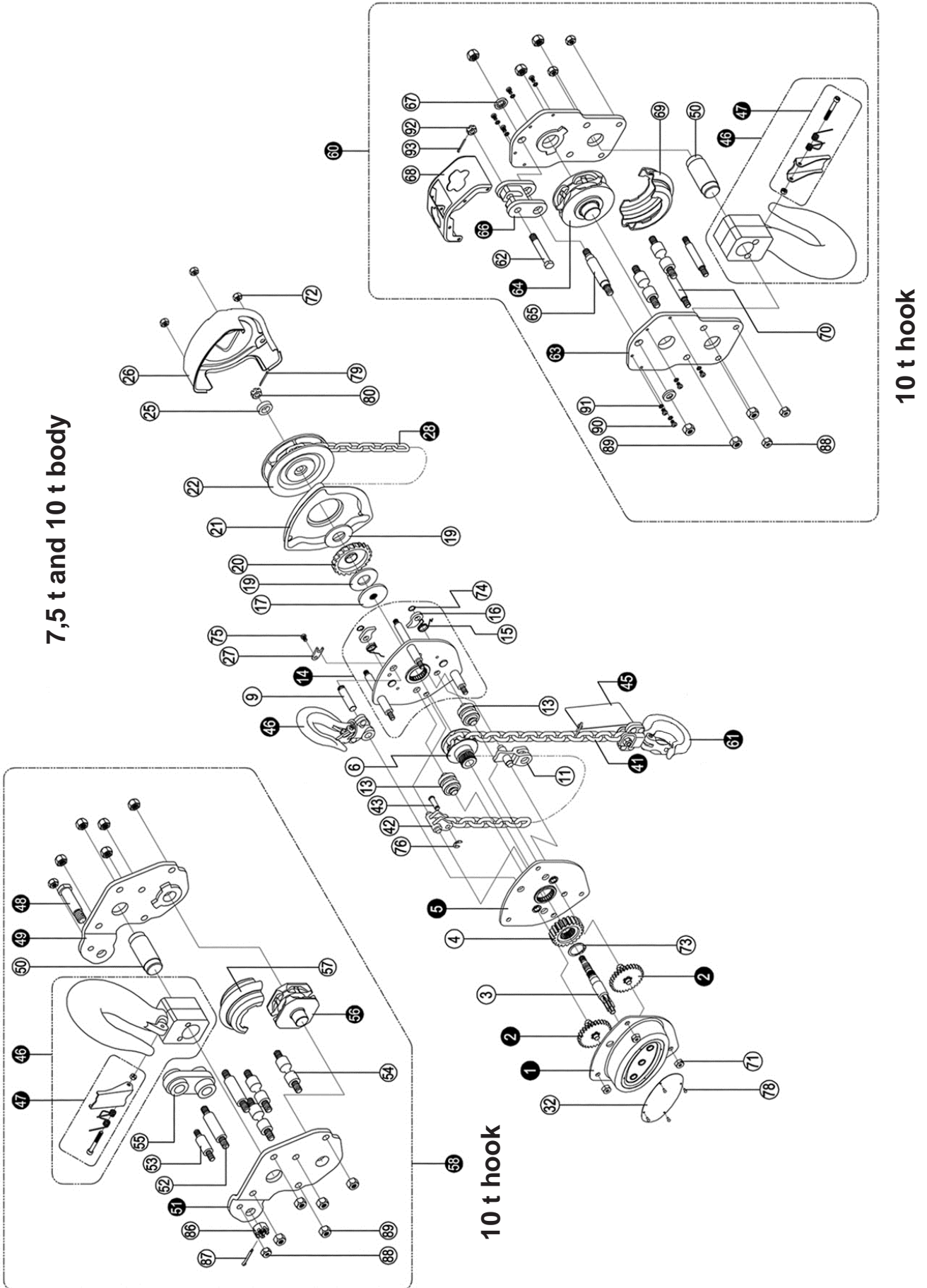

**Parts list 10 t**

Pos	Description	Pos	Description
1	Gear cover assy	54	Stay bolt B
2	Disc gear assy	55	Suspension plate
3	Drive shaft	56	Idler sheave assy
4	Splined gear	57	Protection cover
5	Right side plate assy	58	Top hook assy
6	Load chain sprocket	60	Bottom hook assy
9	Top hook shaft	62	Bottom hook pin
11	Chain stripper	63	Hook plate
13	Guide roller	64	Bottom idler sheave assy
14	Left side plate assy	65	Shaft
15	Pawl spring	66	Plate
16	Pawl	67	Washer
17	Brake seat	68	Protection cover
19	Friction plate	69	Cover
20	Ratchet wheel	70	Bolt
21	Brake cover	71	Metal lock nut
22	Hand chain wheel	72	Metal lock nut
25	Washer	73	Circlip
26	Hand chain cover	74	Circlip
27	Positioned plate	75	Cross head screw
28	Hand chain	76	Split retainer
32	Name plate	78	Name plate
41	Load chain	79	Split pin
42	End anchor	80	Hexagon nut
43	End anchor pin	86	Hexagon recess nut
45	Warning plate assy	87	Split pin
46	Top hook assy	88	Metal lock nut
47	Safety latch assy	89	Metal lock nut
48	Top hook pin	90	Cross head screw
49	Plate (right)	91	Light spring washer
50	Shaft	92	Hexagon recess nut
51	Plate (left)	93	Split pin
52	Stay bolt A		
53	Short bolt		



## CertMax+

The CertMax+ system is a unique leading edge certification management system which is ideal for managing a single asset or large equipment portfolio across multiple sites. Designed by the Lifting Solutions Group, to deliver optimum asset integrity, quality assurance and traceability, the system also improves safety and risk management levels.



## Marking

The POWERTEX Chain Block is equipped with a RFID (Radio-Frequency IDentification) tag, which is a small electronic device, that consist of a small chip and an antenna. It provides a unique identifier for the block.



The POWERTEX Chain Block is **CE** and **UKCA** marked.

Standard: EN 13157



## Warning tag

The warning tag shows some specific and important situations, in which you must pay special attention, when using POWERTEX Chain Blocks and Lever Hoists.



## User Manuals

You can always find the valid and updated User Manuals on the web. The manual is updated continuously and valid only in the latest version.

**NB!** The English version is the Original instruction.

The manual is available as a download under the following link:  
[www.powertex-products.com/manuals](http://www.powertex-products.com/manuals)



### Product compliance and conformity



SCM Citra OY  
 Asessorinkatu 3-7  
 20780 Kaarina  
 Finland  
[www.powertex-products.com](http://www.powertex-products.com)

**POWERTEX**

---

[www.powertex-products.com](http://www.powertex-products.com)